

Self priming centrifugal pumps B series

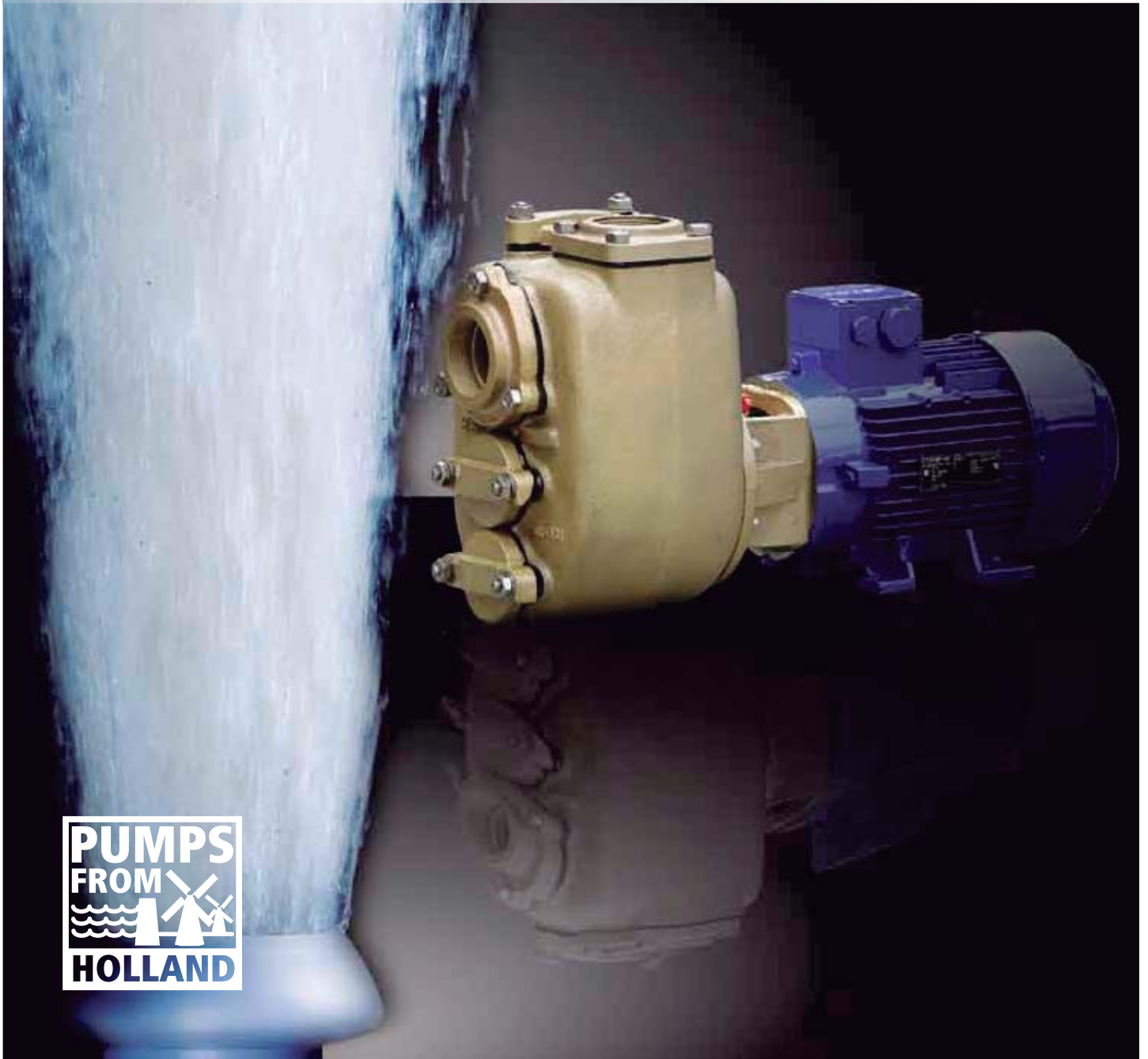

P u m p s f o r r e s u l t s



Characteristics

The BBA self-priming pumps are most suitable for pumping clean or polluted liquids.

The pumps are constructed with an open impeller which is running against a changeable wearplate. As there are few revolving parts in contact with the liquid, pump wear is minimal. Furthermore, large cleaning openings are provided. Several types can be fitted with a stainless steel cutting blade in the impeller for liquids containing fibrous materials.

All this in combination with a grease-cooled shaft seal guarantees correct operation of the pump. This construction ensures that the pump can run dry for short periods and be primed without a foot valve.



- **Simple construction**
- **Large free passage**
- **Resistant to wear**
- **Rapidly self-priming unit**
- **Cooled shaft seal**
- **Long life**
- **ATEX approved**

Applications

- **Shipping**
As bilge pump, deck washing pump, sewage pump or manure pump.
- **Industry**
For pumping clean, polluted or sand-laden water, aggressive solutions and mineral oil products.
- **Construction**
For well-pointing, drainage of waterways, water jet drilling of well filters and piles.
- **Waste water**
For pumping sewage and industrial waste during construction of an emergency pumping station.
- **Water companies**
For emergency pump-drainage sets; features rapid deployment and high capacity.
- **Irrigation**
For surface and sprinkler irrigation.
- **Farm**
Pumping slurry, flushing water and waste water.
- **Horticulture**
Vegetable washing plants.

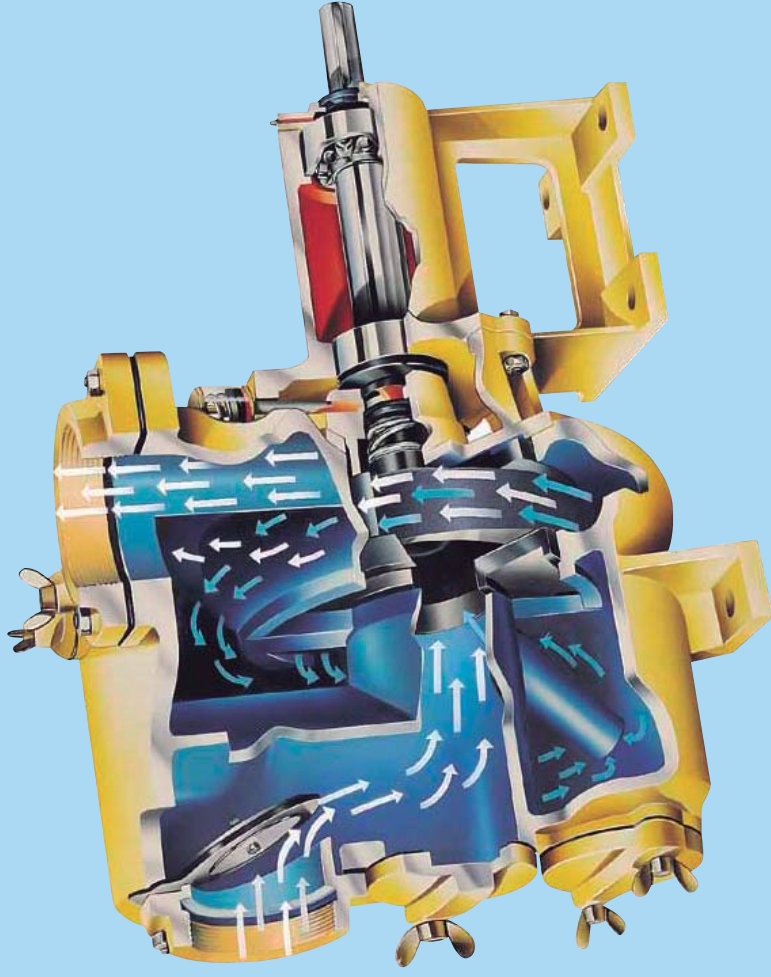

Operation of the self-priming pump

The rotation of the impeller draws the air present in the suction pipe into the pump casing. The air mixes with the liquid present in the pump casing (see drawing; air=white arrows, liquid=blue arrows). Liquid and air are transported to the discharge outlet. When all the air has been removed

from the suction pipe, the pump draws in liquid. The built-in non-return valve at the suction side prevents the pump casing from being siphoned empty when the pump stops. In this way, some liquid will always remain in the pump casing, so immediate re-prime is always possible.

General specifications	
Capacity	up to 1,200 m ³ /h
Head	up to 74 m. water column
Density of liquid	500 to 1,200 kg/m ³
Max. medium temperature	120° C
Min. medium temperature	-20° C
Max. system pressure	12 bar
Shaft seal	mechanical seal
RPM	up to 3,600 rpm
Direction of rotation	clockwise, viewed from the shaft end (B300 also anti-clockwise for direct tractor drive)
Suction head	up to 8 m.w.c. (26 ft)

Summary graph

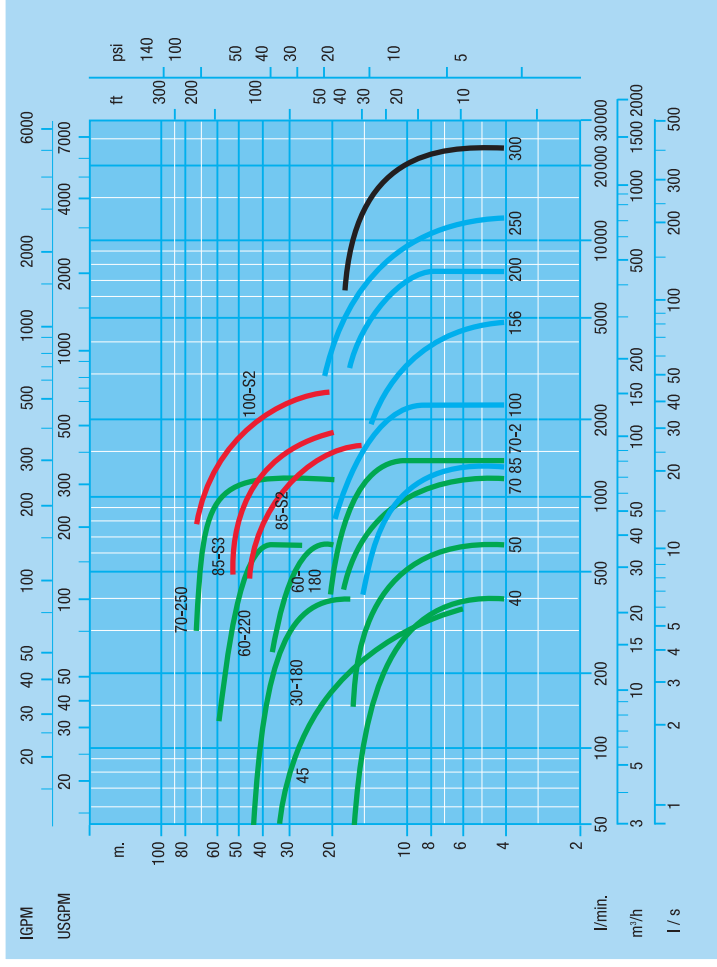

ATEX explosion proof



The B series is available with explosion proof ATEX certificate.

- Group II
- Category 2 and 3
- Temperature class T1 – T4

II Above-ground	
Category 2	Category 3
<ul style="list-style-type: none"> • No sparks or hot surface • In case of failure, no sparks 	<ul style="list-style-type: none"> • No sparks or hot surface
Suitable for:	Suitable for:
<ul style="list-style-type: none"> • Gas/G = Zone 1 and 2 • Dust/D = Zone 21 or 22 • Temperature class: T1, T2, T3 and T4 	<ul style="list-style-type: none"> • Gas/G = Zone 2 • Dust/D = Zone 22 • Temperature class: T1, T2, T3 and T4

Category 2/3 Zone	Max. allowed liquid temperature	Max. allowed surface temperature
T1	180° C	450° C
T2	180° C	300° C
T3	120° C	200° C
T4	65° C	135° C



BS series

The BS series consists of 5 models from DN 40 (1,5") to DN 80 (3"). The pumps have been designed for speeds of 1.500 to 3.600 rpm and often are driven by a two-pole electric motor. The specific feature of these models is their small size in combination with a large free passage.

All models are available with different shaft seals. These properties make the pump ideally suited for pumping sludge, and with built-in cutting blade, also for liquids containing fibrous pollutants or manure.

MONOBLOCK VERSION

BS series: model BVGM C

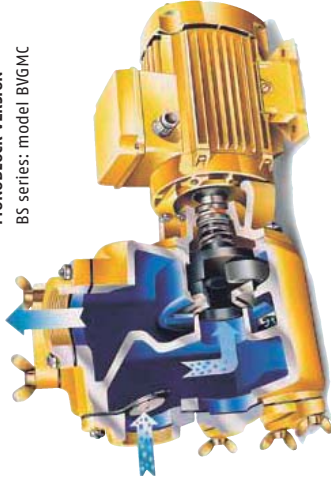

BS series – monoblock or bearing block version

Type	connection		free passage	capacity m³/h		pressure head in m.w.c.		rpm	Motor kW
	mm	inch		max.	min.	min.	max.		
B 40	40	1,5"	18	21	15	10	13	15	1,1
B 45	40	1,5"	14	22	15	10	5	6	2,2
B 50	50	2"	24	35	26	16	5	7	2,2
B 70	80	3"	22	88	60	28	10	5	4
B 70-4	80	3"	30	92	60	30	10	7	5,5

B40 – B70-4 with (BSP) threaded flange.



BN series

The pumps B40, B50, B70 and B30-180 are also available as normbloc version with "push-on" shaft. The pump is available with or without motor. By using the "push-on"

shaft, standard IEC norm motors can be used. The special "push-on" shaft is fixed on the shaft of the E-motor.

BL series

The BL series consists of 10 models from DN 80 (3") to DN 300 (12"). The pumps are designed for speeds from 1.000 to 2.000 rpm. The pump casings are thick-walled, especially in those areas that are subject to wear during pumping of abrasive liquids. All models are available with different shaft seals. Their rugged construction makes them suitable for use under difficult conditions, for continuous operation, for abrasive and aggressive fluids.

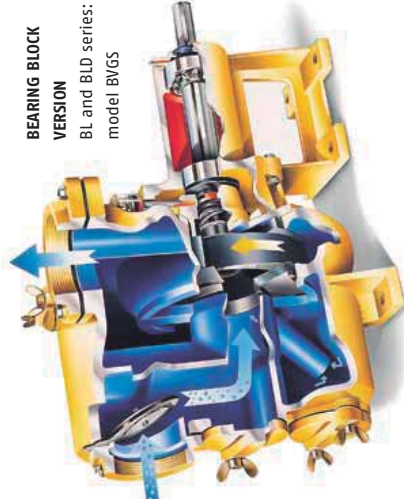

BEARING BLOCK VERSION

BL and BLD series: model BVGS

BL series – monoblock or bearing block version

Type	connection		free passage	capacity m³/h		pressure head in m.w.c.		rpm	Motor kW				
	mm	inch		max.	min.	min.	max.						
B 85	80	3"	40	90	60	34	10	6	11	14	16	1500	5,5
B 100	100	4"	46	140	100	52	10	7	13	16	18,5	1500	7,5
B 156	150	6"	46	260	200	100	50	3	7	12	14	1500	11
B 156-2	150	6"	70	250	170	80	50	2	6	9	9,5	1500	11

BL series – bearing block version

B 150	150	6"	40	300	200	90	50	18	25	30	32	1500	30
B 200	200	8"	80	490	390	220	40	6	12	17	22	1500	37
B 200-S2	200	8"	68	460	280	120	60	6	14	18	20	1500	30
B 200-S3	200	8"	60	430	290	110	50	6	12	17	18,5	1500	30
B 250	250	10"	80	680	540	220	40	2	8	17	20	1500	37
B 300	300	12"	70	1200	1040	440	200	5	8	12	14	1000*	55

B85 and B100 with (BSP) threaded flange. B156 to B300 with flange.

* B300 TWGR 1880 rpm.

BLD series

The BLD series consists of 3 models of similar design as the BL series. However, a special impeller/wearing plate(s) construction gives these pumps a unique capacity/pressure ratio

at 2.900 rpm. The back vanes fitted ensure that solid matters cannot reach the shaft seal.

BLD series – monoblock or bearing block version

Type	connection		free passage	capacity m³/h		pressure head in m.w.c.		rpm	Motor kW				
	mm	inch		max.	min.	min.	max.						
B85-S2	80	3"	15	76	60	30	10	10	28	39	44	2900	11
B85-S3	80	3"	18	86	60	30	10	37	47	53	57	2900	18,5

BLD series – bearing block version

B100-S2	100	4"	25	120	100	50	10	48	56	64	70	2900	30
---------	-----	----	----	-----	-----	----	----	----	----	----	----	------	----

B85 – B100 with (BSP) threaded flange.

BD series

The BD series consists of 4 models from DN 40 (1,5") to DN 80 (3"). The pumps differ from the BS, BL and BLD series in the pump inlet, which is at the drive end, so that high discharge pressures do not cause additional wear on the shaft seal.

The shaft seal has a long life duration, as it carries less load. The suction connection of these pumps can be rotated, so it can be fitted pointing either to the left, to the right or upward.

BD series – monoblock or bearing block version

Type	connection		free passage		capacity m ³ /h		pressure head in m.w.c.		rpm	Motor kW		
	mm	inch	min.	max.	min.	max.	min.	max.				
B30-180	50/40	2,1,5"	12	32	25	11	5	16	32	36,5	2900	4
B60-180	50	2"	18,5	45	36	16	5	10	24	32	35	5,5
B60-220	50	2"	14	46	34	15	5	26	40	50	35	11
B70-250	80	3"	12	76	55	20	10	44	60	73	74	22

B30-180 – B70-250 with (BSP) thread flange.

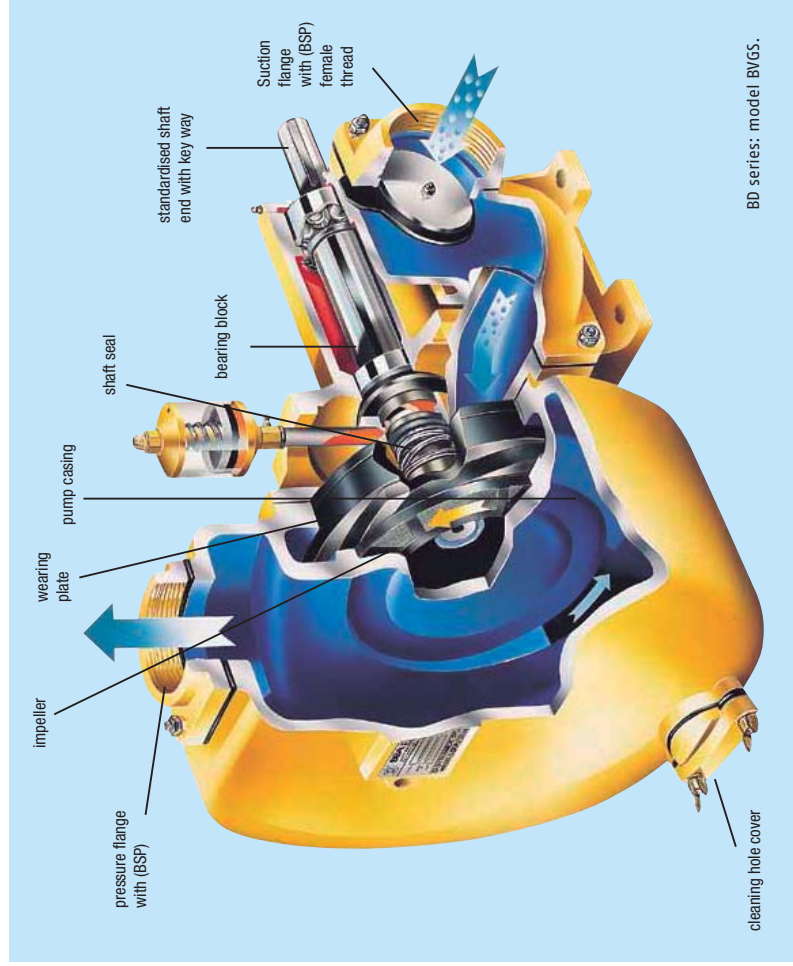

BD series: model BVGS.

Type	B40	Pump size
Seal	BV TW	<ul style="list-style-type: none"> Mechanical seal grease-cooled Standard sic / sic / viton Optional: sic / sic / EPDM TW seal Optional: carbon / ceramic / nitril carbon / ceramic / viton HM /HM / viton
Materials	G B K	<ul style="list-style-type: none"> Cast iron Bronze Stainless steel
Packings	N V E T K	<ul style="list-style-type: none"> Trade names: Perburan®, Hycar, Buna-N, Butracil, ISRN Butakon A Trade names: Viton®, Fluorel, Technoflon Trade names: Kéltan, Nordel, Vistalon, Buna-AP Trade names: Teflon, Tuftrupp® Trade names: Chemraz®

Drives	Mc MM S S/MC S/Mce NMC T R HA DZ	Drives
		<ul style="list-style-type: none"> Monoblock up to 3 kW 230/400V, from 4kW 400/690V Single phase 230V Free shaft end with bearing block Bearing block / base frame / B3 motor Bearing block / base frame / B3 motor, ATEX explosion proof Normblock / B5 – B3 motor Tractor driven pump, anti-clockwise PTO drive Hatz dieselmotor Deutz dieselmotor

Options	+F +FK +BI +BII +KI +KUI +T4W +Z +SP +M +W1 +W2 2 4 +S2 +S3 +E8 +MP +GL +P +VP +T +X	Options
		<ul style="list-style-type: none"> DIN flanges DIN flanges, stainless steel Bronze impeller, stainless steel shaft Bronze impeller, bronze wearing plate, stainless steel shaft Stainless steel impeller and shaft Stainless steel impeller, wearing plate and shaft Teflon packings, Teflon/stainless steel seal parts Zinc anode(s) Flush connection Cutting blade 1-channel impeller 2-blade impeller 4-blade impeller Double wearplate Filling plate and wearplate 3 holes 8 mm in impeller Pump with diaphragm vacuum pump Sound absorbing housing Perma-greaser Grease glass for seal lubrication Handtrolley Carrying handle

Shaft seals

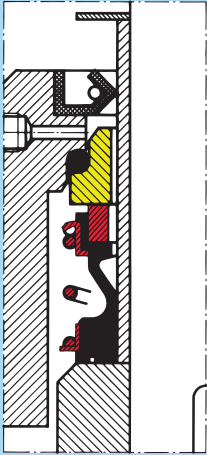

Single mechanical shaft seal according to DIN 24960

Type: Mechanical seal (ϕ_1 VGG)
 Running surfaces: SiC-SiC
 Elastomers: Viton (EPDM optional)
 Other parts: CrNiMo steel
 Photo: Grease-cooled

Code BV.

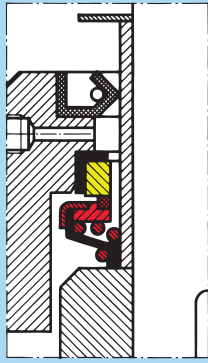

Single mechanical shaft seal TW

Type: TW
 Running surfaces: Tungsten carbide / Tungsten carbide
 Elastomers: Viton-EPDM optional
 Other parts: Stainless steel
 Photo: Grease-cooled

Code TW
 Various seal systems available.



BS series monoblock version

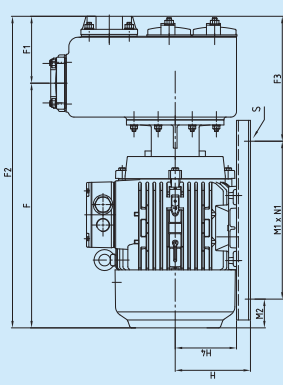

Type	ϕ	A	B	B1	B2	B3	F	F1	F2	H	H1	H2	H3	H4	M1	M2	N1	S	Kg
B40	1 1/2"	-	7	28	116	175	386,8	81,5	468	102	73	183	256	80	160	92,5	215	12	26
B45	1 1/2"	-	6,5	61	112	223	403	118	525	112	83	236	321	90	160	110	215	12	45
B50	2"	-	7	33	93	186	430	120	555	112	97	265	322,5	90	160	110	215	12	44
B70	3"	-	15	40	139	278	492	144	655	162	130	302	432	112	250	103	350	12	102
B70-4	3"	-	15	40	139	278	527	144	671	162	130	302	432	132	340	62	335	14	102

BS series with BSP thread connection.

BS(S) series with bearing block

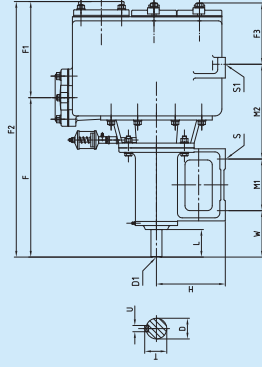

Type	ϕ	B	B1	B2	B3	D1	F	F1	F2	H	H1	H2	H3	L	M1	N	S	T	U	W	Kg
B40	1 1/2"	7	28	116	175	19	278	81,5	360	112	73	193	266	42	50	100	11	21,5	6	79	20
B45	1 1/2"	6,5	61	112	223	19	276	118	398	112	83	236	321	42	50	100	11	21,5	6	79	33
B50	2"	7	33	93	186	19	303	120	428	112	97	265	314	42	50	100	11	21,5	6	79	32
B70	3"	15	40	139	278	28	362	144	506	132	130	272	402	70	124	12	31	8	105	56	
B70-4	3"	15	40	139	278	28	362	144	506	132	130	272	402	70	124	12	31	8	105	56	

BS series with BSP thread connection.

BN/MC series normblock pump (with "push-on" shaft) with motor

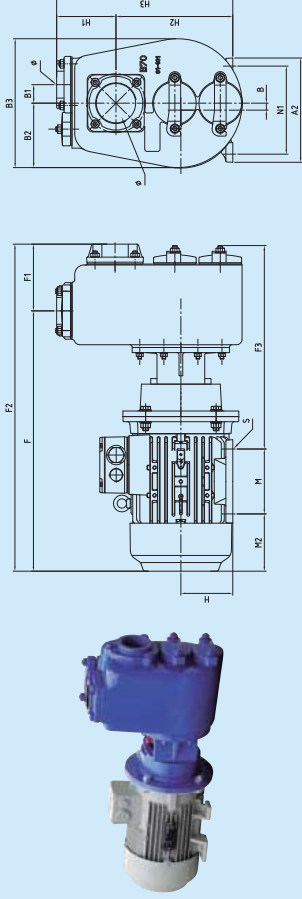

Type	θ	A2	B	B1	B2	B3	F	F1	F2	F3	H	H1	H2	H3	M1	M2	N	N1	S	Kg
B40	1/4"	165	7	28	116	175	396	81,5	477	-	80	73	183	256	100	-	-	125	9,5	30
B45	1/2"	165	6,5	61	112	223	460	118	582	-	90	83	214	297	125	-	-	140	10	49
B50	2"	165	7	33	93	186	487	120	612	-	90	97	194,5	294	125	-	-	140	10	48
B70	3"	225	15	40	139	278	562	144	765,5	-	112	130	252	380	140	-	-	190	12	106

B40 - B70 with BSP thread connection.

BN series normblock pump (with "push-on" shaft) without motor

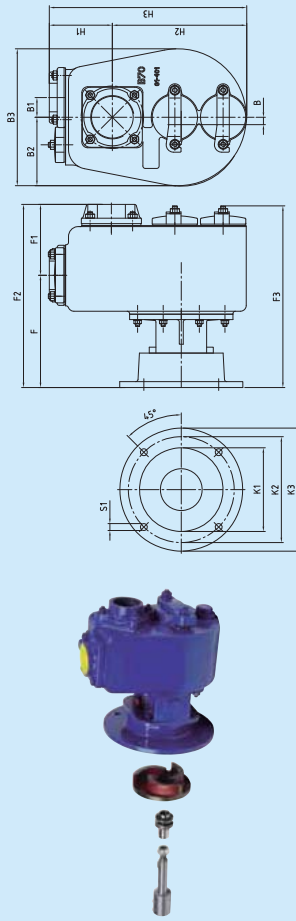

Type	θ	B	B1	B2	B3	F	F1	F2	F3	H	H1	H2	H3	K1	K2	K3	S1	Z	Kg
B40	1/4"	7	28	116	175	162	81,5	244	248	-	73	181	254	130	165	200	12	4	19
B45a	1/2"	6,5	61	112	223	179	118	297	301	-	83	224	319	135	165	200	12	4	33
B50	2"	7	33	93	186	206	120	326	331	-	97	204	301	135	165	200	12	4	32
B70	3"	15	40	139	278	228	144	372	369	-	130	267	393	170	215	250	14	4	64

B40 - B70 with BSP thread connection.

BL(D) series monoblock version

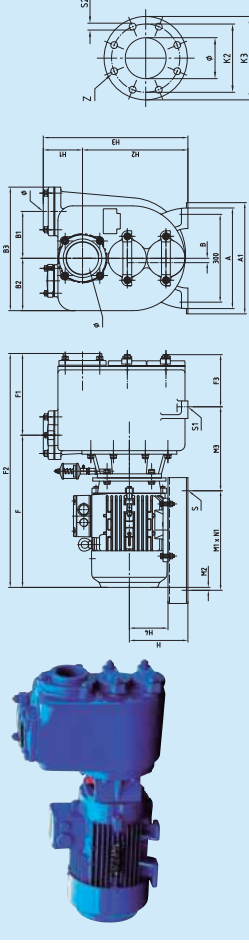

Type	θ	A	B	B1	B2	B3	F	F1	F2	F3	H	H1	H2	H3	H4	K2	K3	M1	M2	M3	N	N1	S	S1	Z	Kg
B85	3"	380	15	70	160	320	572,5	166	738	370	162	101,5	312,5	414	132	-	-	340	28	-	330	14	-	-	-	132
B85 S2	3"	380	15	70	160	320	572,5	166	738	388	162	101,5	312,5	414	132	-	-	340	10	-	330	14	-	-	-	176
B85 S3	3"	380	15	70	160	320	661	166	827	483,5	-	101,5	310,5	412	160	-	-	254	117	-	254	14	-	-	-	194
B100	4"	334	-	160	179	422	520	279	854	178	200	132	360	494	132	-	-	340	10	287	335	300	14	-	-	186
B156	160	410	10	74	233	466	702	300	1002	236	-	175	494	688	160	240	285	210	161	395	350	254	14	18	8	474

B85-B100 with BSP thread connection. B156 with flange.

BL(D) series bearing block version

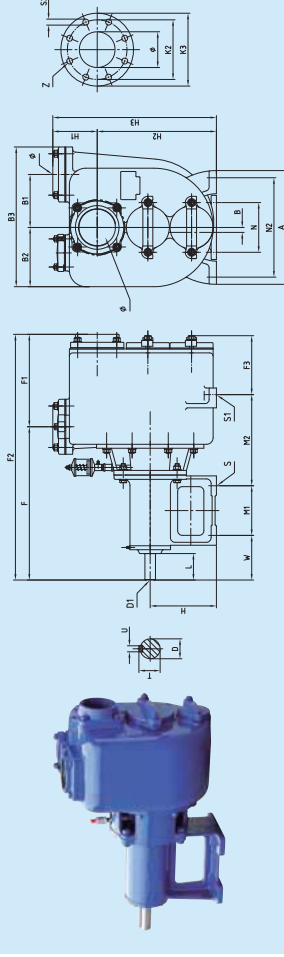

Type	θ	A	B	B1	B2	B3	D1	F	F1	F2	F3	H	H1	H2	H3	K2	K3	L	M1	M2	N	N1	S	S1	T	U	W	Z	S2	Kg
B85	3"	-	15	70	179	320	32	516	166	681	-	200	102	350	452	-	-	80	150	-	150	-	15	-	35	10	135	-	-	98
B85-S2	3"	-	15	70	179	320	32	516	166	681	-	200	102	350	452	-	-	80	150	-	150	-	15	-	35	10	135	-	-	98
B85-S3	3"	-	15	70	179	320	32	516	166	681	-	200	102	350	451	-	-	80	150	-	150	-	15	-	35	10	135	-	-	98
B100	4"	344	-	160	179	422	32	516	279	742	178	200	132	360	494	-	-	80	150	275	150	300	15	14	35	10	135	-	-	136
B100S2	4"	344	-	160	179	422	32	516	279	742	178	200	132	360	494	-	-	80	150	275	150	300	15	14	35	10	135	-	-	136
B156	160	410	10	74	233	466	32	516	300	876	236	200	175	494	688	240	285	80	150	335	150	350	15	18	35	10	135	8	8	256
B156-2	160	410	10	74	233	466	32	516	300	876	236	200	175	494	688	240	285	80	150	335	150	350	15	18	35	10	135	8	8	256

B85-B100 with BSP thread connection. B156 with flange.

BL-S series with bearing block

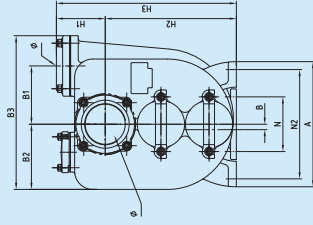
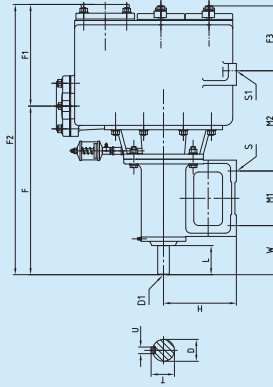

Type	ø	A	B	B1	B2	B3	D1	F	F1	F2	F3	H	H1	H2	H3	K3	L	M1	M2	N	N1	S	S1	T	U	W	Z	S2	kg	
B150	150	490	10	135	290	580	60	757	260	1027	235	283	164	508	672	240	285	105	604,5	-	130	450	18	18	64	18	172	8	18	475
B200	200	535	-	110	400	578	60	847	255	1128	270	283	198	569	767	280	310	105	627	-	130	450	18	18	64	18	172	8	18	341
B200-S2	200	535	-	110	400	578	60	847	255	1128	270	283	198	569	767	280	310	105	627	-	130	450	18	18	64	18	172	8	18	395
B200-S3	200	535	-	110	400	578	60	847	255	1128	270	283	198	569	767	280	310	105	627	-	130	450	18	18	64	18	172	8	18	395
B250	275	515	-	169	314	583	60	817	381	1128	250	283	255	734	893	350	395	105	647	-	130	450	18	18	64	18	172	8	18	420
B300	325	540	-	223,5	400	853	60	602	565	1212	380	480	280	862	1140	400	445	117	550	-	130	450	18	18	64	18	172	12	22	660

B150 – B300 with flange connection.



BD series monoblock version

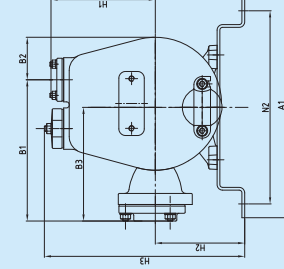
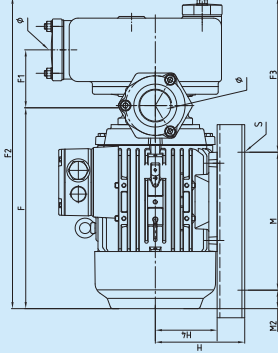

Type	ø	ø	A	B	B1	B2	B3	F	F1	F2	F3	H	H1	H2	H3	H4	M1	M2	N1	S	S1	T	U	W	kg
B30-180	1 1/2"	2"	-	-	256	77	206	368	101	565	-	162	189	162	351	112	250	33,5	350	12	-	31	8	45	85
B60-180	2"	2"	-	-	206	149	206	401	111	645	-	217	143	360	132	140	145	216	12	-	-	31	8	45	115
B60-220	2"	2"	-	-	232	172	232	416	133,5	667	-	175	220	175	395	132	300	32	350	18	-	35	10	55	170
B70-250	3"	3"	-	-	356	198	356	646	163,5	957	-	162	180	475	180	279	186,5	279	15	-	-	35	10	55	225

B30-180 – B70-250 with BSP thread connection.

BD-S series bearing block version

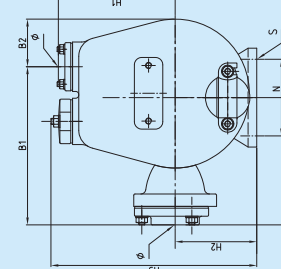
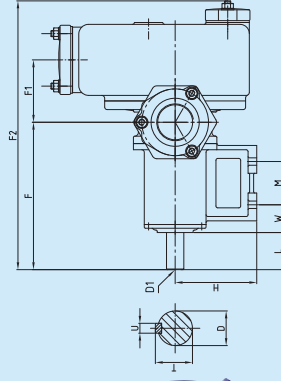

Type	ø	ø	A	B	B1	B2	B3	D1	F	F1	F2	F3	H	H1	H2	H3	L	M1	M2	N	N1	S	S1	T	U	W	kg
B30-180	1 1/2"	2"	-	-	256	77	206	28	239	101	435	-	132	189	132	333	60	70	-	124	-	12	-	31	8	45	40
B60-180	2"	2"	-	-	206	149	206	28	237	111	482	-	132	217	132	370	60	70	-	125	-	12	-	31	8	45	43
B60-220	2"	2"	-	-	232	172	232	32	353	133,5	610	-	200	220	200	430	80	150	-	150	-	15	-	35	10	55	82
B70-250	3"	3"	-	-	356	198	356	32	367	163,5	677	-	200	162	321	483	80	150	-	150	-	15	-	35	10	55	117

B30-180 – B70-250 with BSP thread connection.

BBA Pumps BV

Edisonstraat 12

Postbus 498

7000 AL Doetinchem

The Netherlands

p +31 (0)314-368 436

f +31 (0)314-378 403

e info@bbapumps.com

i www.bbapumps.com

